

## 4-3 Ultrafast Recovery Diodes

### ●Surface-Mount

V <sub>RM</sub> (V)	I <sub>F</sub> (AV) (A) <small>Values in parentheses are for the products with heatsinks</small>	Package	Part Number	I <sub>FSM</sub> (A) 50Hz <small>Single Half Sine Wave</small>	T <sub>j</sub> (°C)	T <sub>stg</sub> (°C)	V <sub>F</sub> (V) max	I <sub>F</sub> (A)	I <sub>R</sub> (μA) V <sub>R</sub> =V <sub>RM</sub> max	I <sub>R</sub> (H) (mA) V <sub>R</sub> =V <sub>RM</sub> max	T <sub>j</sub> (°C)	trr <sup>(1)</sup> (ns)		trr <sup>(2)</sup> (ns)		R <sub>th(j-l)</sub> (°C/W)	Mass (g)
												I <sub>F</sub> /I <sub>RP</sub> (mA)	I <sub>F</sub> /I <sub>RP</sub> (mA)				
200	1.0	Surface-Mount (SJP)	SJPL-D2	25	-40 to +150	0.98	1.0	25	0.1	150	50	100/100	35	100/200	20	0.072	
	1.5	Surface-Mount (SJP)	SJPX-F2	30	-40 to +150	0.98	1.5	10	2.0	150	30	100/100	25	100/200	20	0.072	
	2.0	Surface-Mount (SJP)	SJPL-H2	25	-40 to +150	0.98	2.0	50	0.2	150	50	100/100	35	100/200	20	0.072	
	3.0	Surface-Mount (SJP)	SJPL-L2	60	-40 to +150	0.98	3.0	50	0.3	150	50	100/100	35	100/200	20	0.072	
	3.0	Surface-Mount (D pack)	SPX-G32S	80	-40 to +150	0.98	3.0	50	10	100(Ta)	30	100/100	25	100/200	5.0	0.41	
	6.0	Surface-Mount (D pack)(Center-tap)	SPX-62S	80	-40 to +150	0.98	3.0	50	10	150	30	100/100	25	100/200	5.0	0.41	
	10	Surface-Mount (TO220S)	MPL-102S	65	-40 to +150	0.98	5.0	100	0.2	150(Ta)	40	100/100	30	100/200	2.5	1.4	
300	2.0	Surface-Mount (SJP)	SJPX-H3	20	-40 to +150	1.3	2.0	50	3.0	150	30	100/100	25	100/200	20	0.072	
400	1.5	Surface-Mount(SJP)	SJPL-F4	25	-40 to +150	1.3	1.5	10	0.05	150(Ta)	50	100/100	35	100/200	20	0.072	
	3.0	Surface-Mount(SJP)	SJPL-L4	30	-40 to +150	1.3	3.0	50	0.1	150	50	100/100	35	100/200	20	0.072	
500	1.0	Surface-Mount(SJP)	SJPD-D5*	20	-40 to +150	1.4	1.0	10	0.1	150	40	100/100	30	100/200	20	0.072	
	3.0	Surface-Mount(SJP)	SJPD-L5	50	-40 to +150	1.4	3.0	15	0.15	150	50	100/100	35	100/200	20	0.072	
600	2.0	Surface-Mount (SJP)	SJPL-H6	30	-40 to +150	1.5	2.0	50	0.1	150	50	100/100	35	100/200	20	0.072	
	2.0	Surface-Mount (SJP)	SJPX-H6	20	-40 to +150	1.5	2.0	10	3.0	150	30	100/100	20	100/200	20	0.072	
	3.0	Surface-Mount (TO220S)	MPL-1036S	50	-40 to +150	1.75	3.0	50	0.1	150	50	100/100	-	-	2.5	1.4	

\*Under development

### ●Thru-Hole

V <sub>RM</sub> (V)	I <sub>F</sub> (AV) (A) <small>Values in parentheses are for the products with heatsinks</small>	Package Axial <small>(Body Diameter/Lead Diameter)</small>	Part Number	I <sub>FSM</sub> (A) 50Hz <small>Single Half Sine Wave</small>	T <sub>j</sub> (°C)	T <sub>stg</sub> (°C)	V <sub>F</sub> (V) max	I <sub>F</sub> (A)	I <sub>R</sub> (μA) V <sub>R</sub> =V <sub>RM</sub> max	I <sub>R</sub> (H) (mA) V <sub>R</sub> =V <sub>RM</sub> max	T <sub>j</sub> (°C)	trr <sup>(1)</sup> (ns)		trr <sup>(2)</sup> (ns)		R <sub>th(j-l)</sub> (°C/W)	Mass (g)
												I <sub>F</sub> /I <sub>RP</sub> (mA)	I <sub>F</sub> /I <sub>RP</sub> (mA)				
200	1.0	Axial (φ 2.4/φ 0.6)	AL01Z	25	-40 to +150	0.98	1.0	50	0.1	100	50	100/100	35	100/200	22	0.13	
	1.5	Axial (φ 2.7/φ 0.6)	EN01Z	50	-40 to +150	0.92	1.5	10	2.0	150	100	100/100	50	100/200	20	0.2	
	1.5	Axial (φ 2.7/φ 0.78)	EL 1Z	25	-40 to +150	0.98	1.5	50	0.1	100	50	100/100	35	100/200	17	0.3	
	1.5	Axial (φ 2.7/φ 0.6)	EL02Z	25	-40 to +150	0.98	1.5	50	0.1	100	40	100/100	30	100/200	20	0.2	
	1.5	Axial (φ 4.0/φ 0.78)	RN 1Z	60	-40 to +150	0.92	1.5	20	3.0	150	100	100/100	50	100/200	15	0.4	
	2.0	Axial (φ 4.0/φ 0.78)	RX 10Z	30	-40 to +150	0.98	2.0	50	3.0	150	30	100/100	25	100/200	15	0.4	
	2.0	Axial (φ 4.0/φ 0.78)	RL 10Z	30	-40 to +150	0.98	2.0	50	0.1	100(Ta)	50	100/100	35	100/200	15	0.4	
	2.0	Axial (φ 4.0/φ 0.98)	RL 2Z	30	-40 to +150	0.98	2.0	50	0.1	150	50	100/100	35	100/200	12	0.6	
	2.0	Axial (φ 4.0/φ 0.98)	RN 2Z	70	-40 to +150	0.92	2.0	50	4.0	150	100	100/100	50	100/200	12	0.6	
	3.5	Axial (φ 6.5/φ 1.4)	RL 4Z	80	-40 to +150	0.95	3.5	150	0.5	150	50	100/100	35	100/200	8.0	1.2	
	3.5	Axial (φ 6.5/φ 1.4)	RN 4Z	120	-40 to +150	0.92	3.5	50	6.0	150	100	100/100	50	100/200	8.0	1.2	
	5.0	TO-220F (Center-tap)	FML-12S	35	-40 to +150	0.98	2.5	50	0.1	150	40	100/100	30	100/200	4.0	2.1	
	5.0	TO-220F (Center-tap)	FMX-12S	35	-40 to +150	0.98	2.5	50	10	150	30	100/100	25	100/200	4.0	2.1	
	5.0	TO-220F2Pin	FML-G12S	65	-40 to +150	0.98	5.0	100	0.2	150	40	100/100	30	100/200	4.0	2.1	
	5.0	TO-220F2Pin	FMX-G12S	65	-40 to +150	0.98	5.0	100	20	150	30	100/100	25	100/200	4.0	2.1	
	5.0	TO-220F2Pin	FMN-G12S	100	-40 to +150	0.92	5.0	100	10	150(Ta)	100	100/100	50	100/200	4.0	2.1	
	10	TO-220F (Center-tap)	FMXA-2102ST	100	-40 to +150	1.2	5.0	100	20	150	25	500/500	-	-	4.0	2.1	
	10	TO-220F (Center-tap)	FML-22S	65	-40 to +150	0.98	5.0	100	0.2	150	40	100/100	30	100/200	4.0	2.1	
	10	TO-220F (Center-tap)	FMX-22S	65	-40 to +150	0.98	5.0	100	20	100(Ta)	30	100/100	25	100/200	4.0	2.1	
	10	TO-220F2Pin	FML-G22S	150	-40 to +150	0.98	10	200	0.4	150	40	500/500	30	500/1000	4.0	2.1	
	10	TO-220F2Pin	FMX-G22S	150	-40 to +150	0.98	10	200	50	100(Ta)	30	500/500	25	500/1000	4.0	2.1	
	15	TO-220F (Center-tap)	FMX-22SL	100	-40 to +150	0.98	7.5	150	30	150	30	500/500	25	500/1000	4.0	2.1	
	20	TO-220F (Center-tap)	FM2-2202	110	-40 to +150	0.98	10	200	0.4	150	50	100/100	35	100/200	4.0	2.1	
	20	TO-220F (Center-tap)	FMXA-2202S	100	-40 to +150	1.2	10	100	30	150	25	500/500	-	-	4.0	2.1	
	20	TO-3PF (Center-tap)	FML-4202S	150	-40 to +150	0.98	10	10	0.4	150	40	500/500	30	500/1000	2.0	6.5	
	20	TO-3PF (Center-tap)	FMX-4202S	150	-40 to +150	0.98	10	200	50	150	30	500/500	25	500/1000	2.0	6.5	
	20	TO-3PF (Center-tap)	FMXA-4202S*	100	-40 to +150	1.2	10	100	30	150	25	500/500	-	-	2.0	6.5	
20	TO-3PF (Center-tap)	FMXS-4202S	150	-40 to +150	1.05	10	50	30	150	30	500/500	25	500/1000	2.0	6.5		
300	5.0	TO-220F (Center-tap)	FML-13S	40	-40 to +150	1.3	2.5	50	0.25	100(Ta)	50	100/100	35	100/200	4.0	2.1	
	5.0	TO-220F2Pin	FML-G13S	70	-40 to +150	1.3	5.0	100	0.2	100(Ta)	50	100/100	35	100/200	4.0	2.1	
	10	TO-220F (Center-tap)	FML-23S	75	-40 to +150	1.3	5.0	100	0.2	150	50	100/100	30	100/200	4.0	2.1	
	10	TO-220F (Center-tap)	FMX-23S	65	-40 to +150	1.3	5.0	50	15	150	30	100/100	25	100/200	4.0	2.1	
	15	TO-220F (Center-tap)	FMXA-2153S	75	-40 to +150	1.3	7.5	75	23	150	25	500/500	-	-	4.0	2.1	
	20	TO-220F (Center-tap)	FMX-2203	100	-40 to +150	1.3	10	100	30	150(Ta)	30	500/500	25	500/1000	4.0	2.1	
	20	TO-3PF (Center-tap)	FMX-4203S	100	-40 to +150	1.3	10	100	30	150	30	500/500	25	500/1000	2.0	6.5	
	20	TO-220F (Center-tap)	FMXA-2203S	100	-40 to +150	1.3	10	100	30	150	25	500/500	-	-	4.0	2.1	
20	TO-3PF (Center-tap)	FMXA-4203S	100	-40 to +150	1.3	10	100	30	150	25	500/500	-	-	2.0	6.5		

\*Under development

# Package Type (Dimensions)

• No. 1 Surface-Mount (SJP)

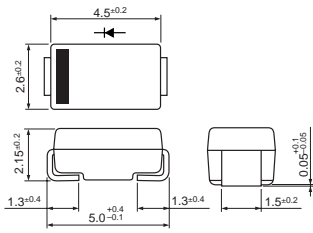

• No. 2 Surface-Mount (D pack)

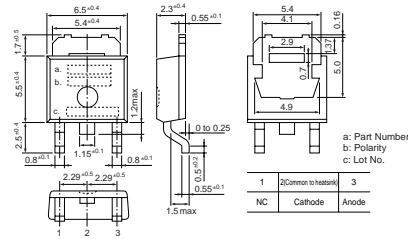

• No. 3 Surface-Mount (D pack) Center-tap

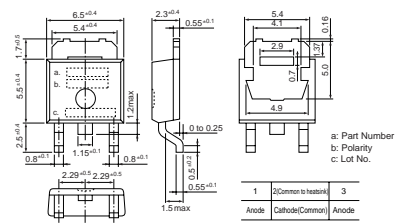

• No. 4 Surface-Mount (TO263)

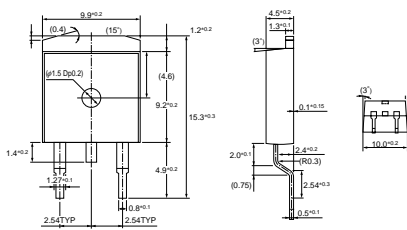

• No. 5 Surface-Mount (TO220S)  
MPL-102S, MP2-202S, MPL-1036

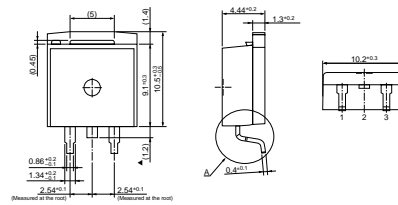

• No. 6 Surface-Mount (TO220S)

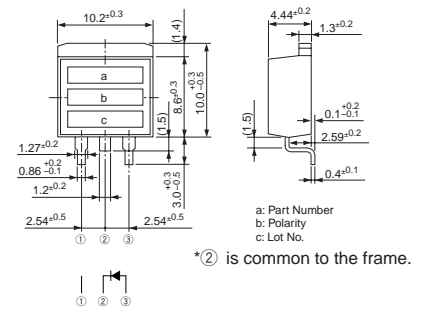

• No. 7 Surface-Mount (TO220S) Center-tap

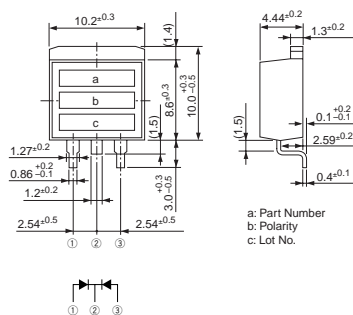

• No. 8 Surface-Mount (SZ-10)

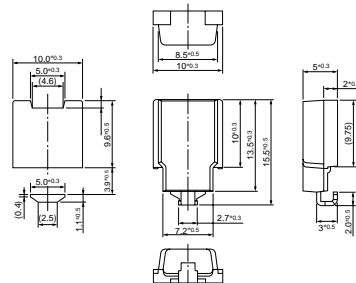

• No. 9 Axial (φ2.4/φ0.6)

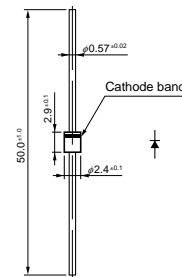

• No. 10 Axial (φ2.7/φ0.6)

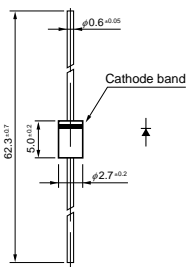

• No. 11 Axial (φ2.7/φ0.6)  
Silicon Varistors (Symmetrical)

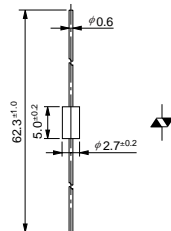

• No. 12 Axial (φ2.7/φ0.78)

