

## 4-4 Schottky Barrier Diodes

### Standard

#### ●Surface-Mount

V <sub>RM</sub> (V)	I <sub>F</sub> (AV) (A)	Package	Part Number	I <sub>FSM</sub> (A)	T <sub>j</sub> (°C)	T <sub>stg</sub> (°C)	V <sub>F</sub> (V) max	I <sub>F</sub> (A)	I <sub>R</sub> (mA)	I <sub>R(H)</sub> (mA)	T <sub>j</sub> (°C)	R <sub>th(j-l)</sub> R <sub>th(j-c)</sub> (°C/W)	Mass (g)
				50Hz Single Half Sine Wave					V <sub>R</sub> =V <sub>RM</sub> max	V <sub>R</sub> =V <sub>RM</sub> max			
40	1.0	Surface-Mount (SJP)	SJPB-D4	30	-40 to +150		0.55	1.0	0.1	35	150	20	0.072
	2.0	Surface-Mount (SJP)	SJPB-H4	50	-40 to +150		0.55	2.0	0.2	70	150	20	0.072
	3.0	Surface-Mount (SJP)	SJPB-L4	60	-40 to +150		0.55	3.0	0.3	100	150	20	0.072
	3.0	Surface-Mount (D pack)	SPB-G34S	50	-40 to +150		0.55	3.0	3.5	100	150	5.0	0.29
	5.0	Surface-Mount (D pack)	SPB-G54S	60	-40 to +150		0.55	5.0	5.0	175	150	5.0	0.29
	6.0	Surface-Mount (D pack)Center-tap	SPB-64S	50	-40 to +150		0.55	3.0	3.5	100	150	5.0	0.29
60	1.0	Surface-Mount (SJP)	SJPB-D6	20	-40 to +150		0.68	1.0	0.1	30	150	20	0.072
	1.5	Surface-Mount (SJP)	SJPW-F6	25	-40 to +150		0.70	1.5	1.0	70	150	20	0.072
	2.0	Surface-Mount (SJP)	SJPB-H6	40	-40 to +150		0.69	2.0	0.2	55	150	20	0.072
	3.0	Surface-Mount (SJP)	SJPB-L6	50	-40 to +150		0.70	3.0	0.3	70	150	20	0.072
	5.0	Surface-Mount (D pack)	SPB-G56S	60	-40 to +150		0.70	5.0	3.0	125	150	5.0	0.29
90	1.0	Surface-Mount (SJP)	SJPB-D9	20	-40 to +150		0.85	1.0	0.1	30	150	20	0.072
	2.0	Surface-Mount (SJP)	SJPB-H9	40	-40 to +150		0.85	2.0	0.2	55	150	20	0.072
100	20	Surface-Mount (TO220S)Center-tap	MPE-220A	120	-40 to +150		0.85	10	1.0	100	150	2.5	1.04

#### ●Thru-Hole

V <sub>RM</sub> (V)	I <sub>F</sub> (AV) (A)	Package Axial (Body Diameter/Lead Diameter)	Part Number	I <sub>FSM</sub> (A)	T <sub>j</sub> (°C)	T <sub>stg</sub> (°C)	V <sub>F</sub> (V) max	I <sub>F</sub> (A)	I <sub>R</sub> (mA)	I <sub>R(H)</sub> (mA)	T <sub>j</sub> (°C)	R <sub>th(j-l)</sub> R <sub>th(j-c)</sub> (°C/W)	Mass (g)
				50Hz Single Half Sine Wave					V <sub>R</sub> =V <sub>RM</sub> max	V <sub>R</sub> =V <sub>RM</sub> max			
40	1.0	Axial(φ2.4/φ0.6)	AK 04	25	-40 to +150		0.55	1.0	5.0	35	150	22	0.13
	1.0	Axial(φ2.7/φ0.6)	EK 04	40	-40 to +150		0.55	1.0	5.0	35	150	20	0.3
	1.5	Axial(φ2.7/φ0.78)	EK 14	40	-40 to +150		0.55	1.5	5.0	50	150	17	0.3
	1.7	Axial(φ4.0/φ0.78)	RK 14	60	-40 to +150		0.55	2.0	5.0	70	150	15	0.45
	2.5	Axial(φ4.0/φ0.98)	RK 34	50	-40 to +150		0.55	2.5	5.0	100	150(Ta)	12	0.6
	3.0	TO-220F2Pin	FMB-G14	60	-40 to +150		0.60	3.0	2.0	70	150	4.0	2.1
	3.0	Axial(φ6.5/φ1.4)	RK 44	80	-40 to +150		0.55	3.0	5.0	100	150	8.0	1.2
	4.0	TO-220F(Center-tap)	FMB-24	50	-40 to +150		0.55	2.0	5.0	250	150	4.0	2.1
	5.0	Axial(φ6.5/φ1.4)	RW54	120	-40 to +150		0.55	5.0	1.0	150	150	8.0	1.2
	5.0	TO-220F2Pin	FMB-G14L	60	-40 to +150		0.55	5.0	5.0	175	150(Ta)	4.0	2.1
	6.0	TO-220F(Center-tap)	FMB-24M	60	-40 to +150		0.55	3.0	5.0	100	150(Ta)	4.0	2.1
	10	TO-220F(Center-tap)	FMB-24L	60	-40 to +150		0.55	5.0	5.0	175	150	4.0	2.1
	10	TO-220F(Center-tap)	FMW-24L	100	-40 to +150		0.55	5.0	0.5	175	150	4.0	2.1
	10	TO-220F2Pin	FMB-G24H	150	-40 to +150		0.55	10	10	350	150	4.0	2.1
	15	TO-220F(Center-tap)	FMB-24H	100	-40 to +150		0.55	7.5	7.5	250	150	4.0	2.1
	15	TO-220F(Center-tap)	FMW-24H	120	-40 to +150		0.55	7.5	7.5	250	150(Ta)	4.0	2.1
	20	TO-220F(Center-tap)	FMB-2204	150	-40 to +150		0.55	10	10	350	150	4.0	2.1
	20	TO-220F(Center-tap)	FMW-2204	120	-40 to +150		0.55	10	1.0	350	150	4.0	2.1
	30	TO-220F(Center-tap)	FMB-2304	150	-40 to +150		0.55	15	15	500	150	4.0	2.1

# Package Type (Dimensions)

• No. 1 Surface-Mount (SJP)



• No. 2 Surface-Mount (D pack)

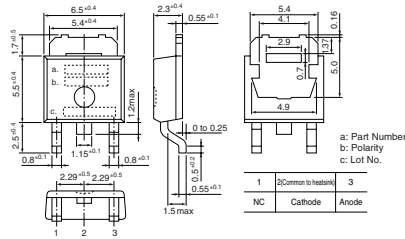

• No. 3 Surface-Mount (D pack) Center-tap

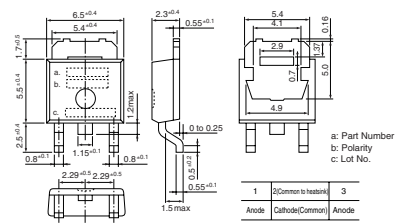

• No. 4 Surface-Mount (TO263)



• No. 5 Surface-Mount (TO220S)  
MPL-102S, MP2-202S, MPL-1036

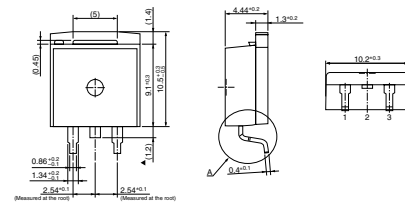

• No. 6 Surface-Mount (TO220S)

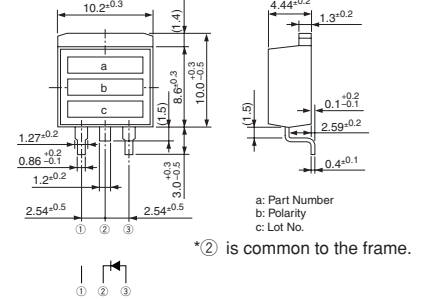

• No. 7 Surface-Mount (TO220S) Center-tap

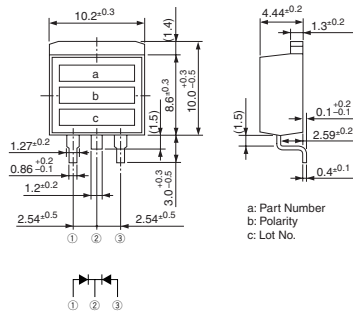

• No. 8 Surface-Mount (SZ-10)

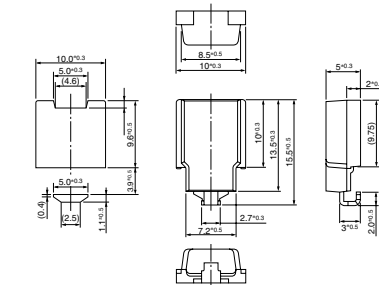

• No. 9 Axial ( $\phi 2.4/\phi 0.6$ )

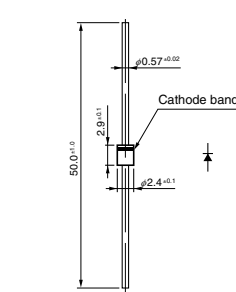

• No. 10 Axial ( $\phi 2.7/\phi 0.6$ )

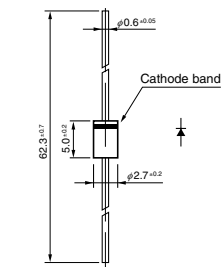

• No. 11 Axial ( $\phi 2.7/\phi 0.6$ )  
Silicon Varistors (Symmetrical)

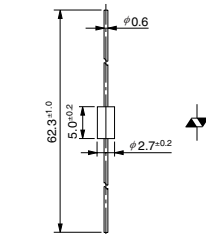

• No. 12 Axial ( $\phi 2.7/\phi 0.78$ )

