

## 4-4 Schottky Barrier Diodes

V <sub>RM</sub> (V)	I <sub>F</sub> (AV) (A)	Package Axial (Body Diameter/Lead Diameter)	Part Number	I <sub>FSM</sub> (A)	T <sub>J</sub> (°C)	T <sub>stg</sub> (°C)	V <sub>F</sub> (V) max	I <sub>F</sub> (A)	I <sub>R</sub> (mA)	I <sub>R</sub> (H) (mA)	T <sub>J</sub> (°C)	R <sub>th(j-l)</sub> R <sub>th(j-c)</sub> (°C/W)	Mass (g)
				50Hz Single Half Sine Wave					V <sub>R</sub> =V <sub>RM</sub> max	V <sub>R</sub> =V <sub>RM</sub> max			
60	0.7	Axial(φ2.4/φ0.6)	AK 06	10	-40 to +150		0.62	0.7	1.0	30	150	22	0.13
	0.7	Axial(φ2.7/φ0.6)	EK 06	10	-40 to +150		0.62	0.7	1.0	30	150	20	0.3
	1.5	Axial(φ2.7/φ0.78)	EK 16	25	-40 to +150		0.62	1.5	1.0	55	150	17	0.3
	1.5	Axial(φ4.0/φ0.78)	RK 16	25	-40 to +150		0.62	1.5	1.0	55	150	15	0.45
	2.0	Axial(φ4.0/φ0.98)	RK 36	40	-40 to +150		0.62	2.0	2.0	70	150(Ta)	12	0.6
	3.5	Axial(φ6.5/φ1.4)	RK 46	70	-40 to +150		0.62	3.5	3.0	125	150	8.0	1.2
	4.0	TO-220F(Center-tap)	FMB-26	40	-40 to +150		0.62	2.0	2.0	70	150	4.0	2.1
	6.0	TO-220F2Pin	FMB-G16L	50	-40 to +150		0.72	6.0	5.0	200	150	4.0	2.1
	10	TO-220F(Center-tap)	FMW-2106	100	-40 to +150		0.70	5.0	3.0	125	150	4.0	2.1
	15	TO-220F(Center-tap)	FMW-2156	100	-40 to +150		0.70	7.5	5.0	175	150	4.0	2.1
	20	TO-220F(Center-tap)	FMW-2206	120	-40 to +150		0.70	10	1.0	250	150	4.0	2.1
	30	TO-220F(Center-tap)	FMB-2306	150	-40 to +150		0.70	15	8.0	400	150	4.0	2.1
30	TO-3PF(Center-tap)	FMW-4306	150	-40 to +150		0.70	15	3.0	350	150	2.0	6.5	
90	0.7	Axial(φ2.4/φ0.6)	AK 09	10	-40 to +150		0.81	0.7	1.0	30	150	22	0.13
	0.7	Axial(φ2.7/φ0.6)	EK 09	10	-40 to +150		0.81	0.7	1.0	30	150	20	0.3
	1.5	Axial(φ2.7/φ0.78)	EK 19	40	-40 to +150		0.81	1.5	2.0	55	150	17	0.3
	1.5	Axial(φ4.0/φ0.78)	RK 19	40	-40 to +150		0.81	1.5	2.0	55	150	15	0.45
	2.0	Axial(φ4.0/φ0.98)	RK 39	50	-40 to +150		0.81	2.0	3.0	70	150(Ta)	12	0.6
	3.5	Axial(φ6.5/φ1.4)	RK 49	60	-40 to +150		0.81	3.5	5.0	125	150	8.0	1.2
	4.0	TO-220F(Center-tap)	FMB-29	50	-40 to +150		0.81	2.0	3.0	55	150	4.0	2.1
	4.0	TO-220F2Pin	FMB-G19L	60	-40 to +150		0.81	4.0	5.0	125	150	4.0	2.1
8.0	TO-220F(Center-tap)	FMB-29L	60	-40 to +150		0.81	4.0	5.0	125	150(Ta)	4.0	2.1	

### Low V<sub>F</sub> "A Series"

#### ●Surface-Mount

V <sub>RM</sub> (V)	I <sub>F</sub> (AV) (A)	Package	Part Number	I <sub>FSM</sub> (A)	T <sub>J</sub> (°C)	T <sub>stg</sub> (°C)	V <sub>F</sub> (V) max	I <sub>F</sub> (A)	I <sub>R</sub> (mA)	I <sub>R</sub> (H) (mA)	T <sub>J</sub> (°C)	R <sub>th(j-l)</sub> R <sub>th(j-c)</sub> (°C/W)	Mass (g)
				50Hz Single Half Sine Wave					V <sub>R</sub> =V <sub>RM</sub> max	V <sub>R</sub> =V <sub>RM</sub> max			
30	1.0	Surface-Mount (SJP)	SJPA-D3	30	-40 to +125		0.36	1.0	1.5	70	100(Ta)	20	0.072
	2.0	Surface-Mount (SJP)	SJPA-H3*	40	-40 to +125		0.36	2.0	3.0	140	100(Ta)	20	0.072
	3.0	Surface-Mount (SJP)	SJPA-L3	70	-40 to +125		0.36	3.0	4.5	210	100	20	0.072

\*Under development

#### ●Thru-Hole

V <sub>RM</sub> (V)	I <sub>F</sub> (AV) (A)	Package Axial (Body Diameter/Lead Diameter)	Part Number	I <sub>FSM</sub> (A)	T <sub>J</sub> (°C)	T <sub>stg</sub> (°C)	V <sub>F</sub> (V) max	I <sub>F</sub> (A)	I <sub>R</sub> (mA)	I <sub>R</sub> (H) (mA)	T <sub>J</sub> (°C)	R <sub>th(j-l)</sub> R <sub>th(j-c)</sub> (°C/W)	Mass (g)
				50Hz Single Half Sine Wave					V <sub>R</sub> =V <sub>RM</sub> max	V <sub>R</sub> =V <sub>RM</sub> max			
30	2.0	Axial(φ4.0/φ0.78)	RA 13	50	-40 to +125		0.36	2.0	3.0	140	100	15	0.45

# Package Type (Dimensions)

• No. 1 Surface-Mount (SJP)

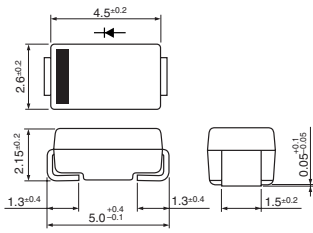

• No. 2 Surface-Mount (D pack)

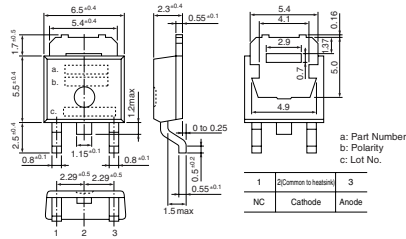

• No. 3 Surface-Mount (D pack) Center-tap

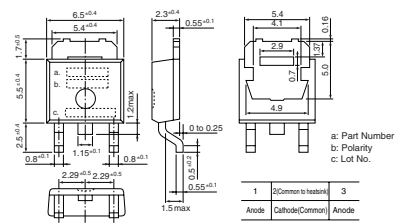

• No. 4 Surface-Mount (TO263)

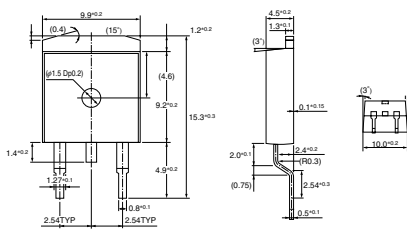

• No. 5 Surface-Mount (TO220S)  
MPL-102S, MP2-202S, MPL-1036

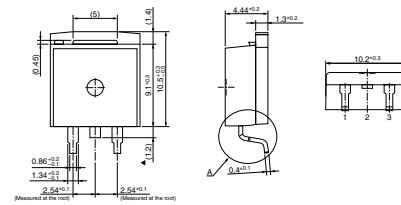

• No. 6 Surface-Mount (TO220S)

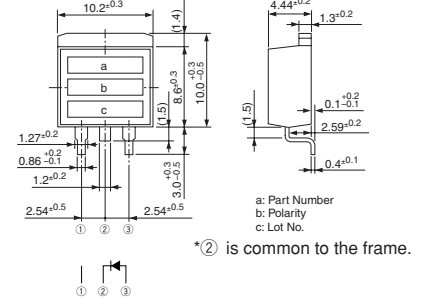

• No. 7 Surface-Mount (TO220S) Center-tap

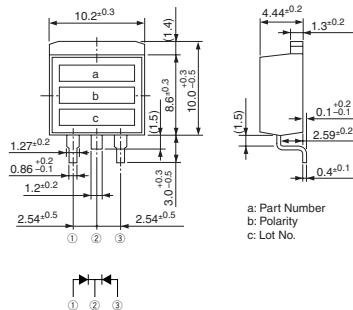

• No. 8 Surface-Mount (SZ-10)

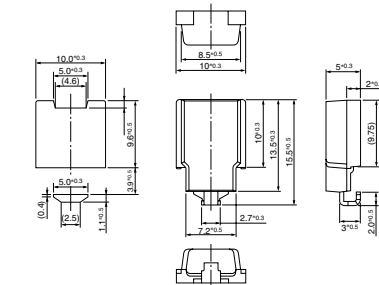

• No. 9 Axial (φ2.4/φ0.6)

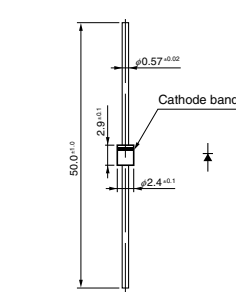

• No. 10 Axial (φ2.7/φ0.6)

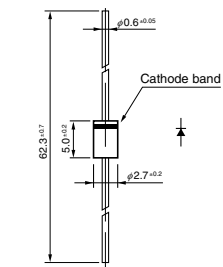

• No. 11 Axial (φ2.7/φ0.6)  
Silicon Varistors (Symmetrical)

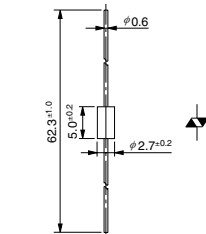

• No. 12 Axial (φ2.7/φ0.78)

