

V _{RM} (V)	I _F (AV) (A) <small>Values in parentheses are for the products with heatsinks</small>	Package Axial <small>Body Diameter/Lead Diameter</small>	Part Number	I _{FSM} (A)	T _j (°C)	T _{stg} (°C)	V _F (V) max	I _F (A)	I _R (μA) V _R =V _{RM} max	I _R (H) (μA) V _R =V _{RM} max	T _j (°C)	trr(1) (μs)	I _F /I _{RP} (mA)	trr(2) (μs)	I _F /I _{RP} (mA)	R _{th(j-l)} R _{th(j-c)} (°C/W)	Mass (g)
				50Hz Single Half Sine Wave													
800	0.25	Axial(φ4.0/φ0.78)	RU 1B	15	-40 to +150	2.5	0.25	10	200	100(Ta)	0.4	10/10	0.18	10/20	15	0.4	
	0.6	Axial(φ4.0/φ0.78)	RF 1B	15	-40 to +150	2.0	1.0	10	200	100	0.4	10/10	0.18	10/20	15	0.4	
	0.6	Axial(φ4.0/φ0.78)	RH 1B	35	-40 to +150	1.3	0.6	5.0	70	150(Ta)	4.0	10/10	1.3	10/20	15	0.4	
	0.7	Axial(φ4.0/φ0.78)	RS 1B	30	-40 to +150	2.5	0.8	10	2000	150	1.5	10/10	0.6	10/20	15	0.4	
	1.0	Axial(φ4.0/φ0.78)	RU 2B	20	-40 to +150	1.5	1.0	10	300	100	0.4	10/10	0.18	10/20	15	0.4	
	1.1	Axial(φ4.0/φ0.98)	RU 3B	20	-40 to +150	1.5	1.0	10	400	100	0.4	10/10	0.18	10/20	12	0.6	
	1.5(3.0)	Axial(φ6.5/φ1.4)	RU 4B	50	-40 to +150	1.6	3.0	10	500	100(Ta)	0.4	10/10	0.18	10/20	8.0	1.2	
1000	0.2	Axial(φ4.0/φ0.78)	RU 1C	15	-40 to +150	3.0	0.25	10	250	100	0.4	10/10	0.18	10/20	15	0.4	
	0.6	Axial(φ4.0/φ0.78)	RH 1C	35	-40 to +150	1.3	0.6	5.0	70	150(Ta)	4.0	10/10	1.3	10/20	15	0.4	
	0.8	Axial(φ4.0/φ0.78)	RU 2C	20	-40 to +150	1.5	1.0	10	300	100(Ta)	0.4	10/10	0.18	10/20	15	0.4	
	1.5	Axial(φ4.0/φ0.98)	RU 3C	20	-40 to +150	2.5	1.5	10	400	100	0.4	10/10	0.18	10/20	12	0.6	
	1.5(2.5)	Axial(φ6.5/φ1.4)	RU 4C	50	-40 to +150	1.6	3.0	50	500	100	0.4	100/100	0.18	100/200	8.0	1.2	
1300	1.5	Axial(φ6.5/φ1.4)	RU 4D	50	-40 to +150	1.8	1.5	50	500	100	0.4	500/500	0.18	500/1000	8.0	1.2	
	1.5(2.5)	Axial(φ6.5/φ1.4)	RU 4DS	50	-40 to +150	1.6	3.0	10	500	100	0.4	500/500	0.18	500/1000	8.0	1.2	
1500	0.5	Axial(φ2.7/φ0.6)	ES01F	15	-40 to +150	2.0	0.5	10	200	100(Ta)	1.5	10/10	0.6	10/20	20	0.2	
	0.5	Axial(φ2.7/φ0.78)	ES 1F	20	-40 to +150	2.0	0.5	10	200	100(Ta)	1.5	10/10	0.6	10/20	17	0.3	
	1.5(2.5)	Axial(φ6.5/φ1.4)	RS 4FS	50	-40 to +150	1.5	3.0	50	500	100	1.0	100/100	0.4	100/200	8.0	1.2	
2000	0.2	Axial(φ4.0/φ0.78)	RC 2	20	-40 to +150	2.0	0.2	10	300	100	4.0	10/10	1.3	10/20	15	0.4	

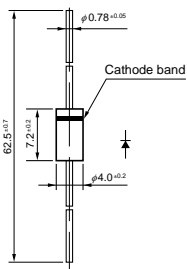

• No. 13 Axial ($\phi 4.0/\phi 0.78$)



• No. 14 Axial ($\phi 4.0/\phi 0.98$)

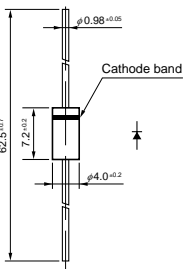

• No. 15 Axial ($\phi 6.5/\phi 1.4$)

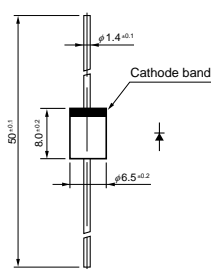

• No. 16 TO-220F (Two Elements)

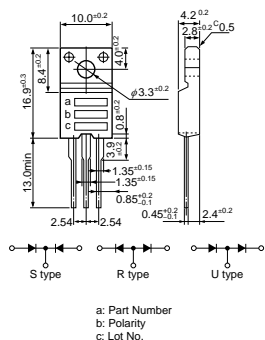

• No. 17 TO-220F (Center-tap)

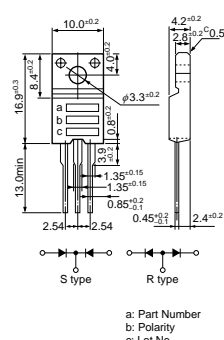

• No. 18 TO-220F2Pin

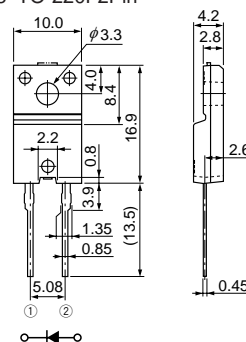

• No. 19 TO-220F2Pin (Two Elements)

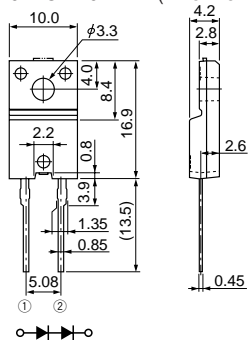

• No. 20 TO-3PF

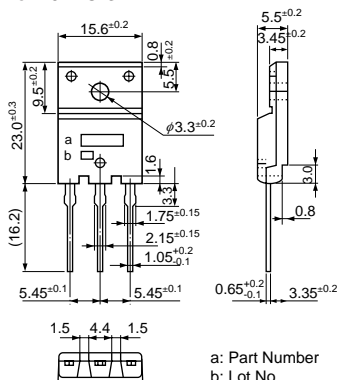

• No. 21 TO-3PF2Pin

