

4-3 Ultrafast Recovery Diodes

●Surface-Mount

V _{RM} (V)	I _F (AV) (A) <small>Values in parentheses are for the products with heatsinks</small>	Package	Part Number	I _{FSM} (A) <small>50Hz Single Half Sine Wave</small>	T _j (°C)	T _{stg} (°C)	V _F (V) max	I _F (A)	I _R (μA)	I _R (H) (mA)	T _j (°C)	trr ^① (ns)	trr ^② (ns)		R _{th(j-l)} (°C/W)	Mass (g)
									<small>V_R=V_{RM} max</small>	<small>V_R=V_{RM} max</small>			I _F /I _{RP} (mA)	I _F /I _{RP} (mA)		
200	1.0	Surface-Mount (SJP)	SJPL-D2	25	-40 to +150	0.98	1.0	25	1.0	150	50	100/100	35	100/200	20	0.072
	1.5	Surface-Mount (SJP)	SJPX-F2	30	-40 to +150	0.98	1.5	10	2.0	150	30	100/100	25	100/200	20	0.072
	2.0	Surface-Mount (SJP)	SJPL-H2	25	-40 to +150	0.98	2.0	50	0.2	150	50	100/100	35	100/200	20	0.072
	3.0	Surface-Mount (SJP)	SJPL-L2	60	-40 to +150	0.98	3.0	50	0.3	150	50	100/100	35	100/200	20	0.072
	3.0	Surface-Mount (D pack)	SPX-G32S	80	-40 to +150	0.98	3.0	50	10	100(Ta)	30	100/100	25	100/200	5.0	0.41
	6.0	Surface-Mount (D pack)/Center-tap	SPX-62S	80	-40 to +150	0.98	3.0	50	10	150	30	100/100	25	100/200	5.0	0.41
300	10	Surface-Mount (TO220S)	MPL-102S	65	-40 to +150	0.98	5.0	100	0.2	150(Ta)	40	100/100	30	100/200	2.5	1.4
	2.0	Surface-Mount (SJP)	SJPX-H3	20	-40 to +150	1.3	2.0	50	3.0	150	30	100/100	25	100/200	20	0.072
400	1.5	Surface-Mount(SJP)	SJPL-F4	25	-40 to +150	1.3	1.5	10	0.05	150(Ta)	50	100/100	35	100/200	20	0.072
	3.0	Surface-Mount(SJP)	SJPL-L4	30	-40 to +150	1.3	3.0	50	0.1	150	50	100/100	35	100/200	20	0.072
500	1.0	Surface-Mount(SJP)	SJPD-D5*	20	-40 to +150	1.4	1.0	10	0.1	150	40	100/100	30	100/200	20	0.072
	3.0	Surface-Mount(SJP)	SJPD-L5	50	-40 to +150	1.4	3.0	15	0.15	150	50	100/100	35	100/200	20	0.072
600	2.0	Surface-Mount (SJP)	SJPL-H6	30	-40 to +150	1.5	2.0	50	0.1	150	50	100/100	35	100/200	20	0.072
	2.0	Surface-Mount (SJP)	SJPX-H6	20	-40 to +150	1.5	2.0	10	3.0	150	30	100/100	20	100/200	20	0.072
	3.0	Surface-Mount (TO220S)	MPL-1036S	50	-40 to +150	1.75	3.0	50	0.1	150	50	100/100	-	-	2.5	1.4

*Under development

●Thru-Hole

V _{RM} (V)	I _F (AV) (A) <small>Values in parentheses are for the products with heatsinks</small>	Package Axial <small>(Body Diameter/Lead Diameter)</small>	Part Number	I _{FSM} (A) <small>50Hz Single Half Sine Wave</small>	T _j (°C)	T _{stg} (°C)	V _F (V) max	I _F (A)	I _R (μA)	I _R (H) (mA)	T _j (°C)	trr ^① (ns)	trr ^② (ns)		R _{th(j-l)} (°C/W)	Mass (g)
									<small>V_R=V_{RM} max</small>	<small>V_R=V_{RM} max</small>			I _F /I _{RP} (mA)	I _F /I _{RP} (mA)		
200	1.0	Axial (φ 2.4/ φ 0.6)	AL01Z	25	-40 to +150	0.98	1.0	50	0.1	100	50	100/100	35	100/200	22	0.13
	1.5	Axial (φ 2.7/ φ 0.6)	EN 01Z	50	-40 to +150	0.92	1.5	10	2.0	150	100	100/100	50	100/200	20	0.2
	1.5	Axial (φ 2.7/ φ 0.78)	EL 1Z	25	-40 to +150	0.98	1.5	50	0.1	100	50	100/100	35	100/200	17	0.3
	1.5	Axial (φ 2.7/ φ 0.6)	EL02Z	25	-40 to +150	0.98	1.5	50	0.1	100	40	100/100	30	100/200	20	0.2
	1.5	Axial (φ 4.0/ φ 0.78)	RN 1Z	60	-40 to +150	0.92	1.5	20	3.0	150	100	100/100	50	100/200	15	0.4
	2.0	Axial (φ 4.0/ φ 0.78)	RX 10Z	30	-40 to +150	0.98	2.0	50	3.0	150	30	100/100	25	100/200	15	0.4
	2.0	Axial (φ 4.0/ φ 0.78)	RL 10Z	30	-40 to +150	0.98	2.0	50	0.1	100(Ta)	50	100/100	35	100/200	15	0.4
	2.0	Axial (φ 4.0/ φ 0.98)	RL 2Z	30	-40 to +150	0.98	2.0	50	0.1	150	50	100/100	35	100/200	12	0.6
	2.0	Axial (φ 4.0/ φ 0.98)	RN 2Z	70	-40 to +150	0.92	2.0	50	4.0	150	100	100/100	50	100/200	12	0.6
	3.5	Axial (φ 6.5/ φ 1.4)	RL 4Z	80	-40 to +150	0.95	3.5	150	0.5	150	50	100/100	35	100/200	8.0	1.2
	3.5	Axial (φ 6.5/ φ 1.4)	RN 4Z	120	-40 to +150	0.92	3.5	50	6.0	150	100	100/100	50	100/200	8.0	1.2
	5.0	TO-220F (Center-tap)	FML-12S	35	-40 to +150	0.98	2.5	50	0.1	150	40	100/100	30	100/200	4.0	2.1
	5.0	TO-220F (Center-tap)	FMX-12S	35	-40 to +150	0.98	2.5	50	10	150	30	100/100	25	100/200	4.0	2.1
	5.0	TO-220F2Pin	FML-G12S	65	-40 to +150	0.98	5.0	100	0.2	150	40	100/100	30	100/200	4.0	2.1
	5.0	TO-220F2Pin	FMX-G12S	65	-40 to +150	0.98	5.0	100	20	150	30	100/100	25	100/200	4.0	2.1
	5.0	TO-220F2Pin	FMN-G12S	100	-40 to +150	0.92	5.0	100	10	150(Ta)	100	100/100	50	100/200	4.0	2.1
	10	TO-220F (Center-tap)	FMXA-2102ST	100	-40 to +150	1.2	5.0	100	20	150	25	500/500	-	-	4.0	2.1
	10	TO-220F (Center-tap)	FML-22S	65	-40 to +150	0.98	5.0	100	0.2	150	40	100/100	30	100/200	4.0	2.1
	10	TO-220F (Center-tap)	FMX-22S	65	-40 to +150	0.98	5.0	100	20	100(Ta)	30	100/100	25	100/200	4.0	2.1
	10	TO-220F2Pin	FML-G22S	150	-40 to +150	0.98	10	200	0.4	150	40	500/500	30	500/1000	4.0	2.1
10	TO-220F2Pin	FMX-G22S	150	-40 to +150	0.98	10	200	50	100(Ta)	30	500/500	25	500/1000	4.0	2.1	
15	TO-220F (Center-tap)	FMX-22SL	100	-40 to +150	0.98	7.5	150	30	150	30	500/500	25	500/1000	4.0	2.1	
20	TO-220F (Center-tap)	FM2-2202	110	-40 to +150	0.98	10	200	0.4	150	50	100/100	35	100/200	4.0	2.1	
20	TO-220F (Center-tap)	FMXA-2202S	100	-40 to +150	1.2	10	100	30	150	25	500/500	-	-	4.0	2.1	
20	TO-3PF (Center-tap)	FML-4202S	150	-40 to +150	0.98	10	10	0.4	150	40	500/500	30	500/1000	2.0	6.5	
20	TO-3PF (Center-tap)	FMX-4202S	150	-40 to +150	0.98	10	200	50	150	30	500/500	25	500/1000	2.0	6.5	
20	TO-3PF (Center-tap)	FMXA-4202S*	100	-40 to +150	1.2	10	100	30	150	25	500/500	-	-	2.0	6.5	
300	5.0	TO-220F (Center-tap)	FML-13S	40	-40 to +150	1.3	2.5	50	0.25	100(Ta)	50	100/100	35	100/200	4.0	2.1
	5.0	TO-220F2Pin	FML-G13S	70	-40 to +150	1.3	5.0	100	0.2	100(Ta)	50	100/100	35	100/200	4.0	2.1
	10	TO-220F (Center-tap)	FML-23S	75	-40 to +150	1.3	5.0	100	0.2	150	50	100/100	30	100/200	4.0	2.1
	10	TO-220F (Center-tap)	FMX-23S	65	-40 to +150	1.3	5.0	50	15	150	30	100/100	25	100/200	4.0	2.1
	15	TO-220F (Center-tap)	FMXA-2153S	75	-40 to +150	1.3	7.5	75	23	150	25	500/500	-	-	4.0	2.1
	20	TO-220F (Center-tap)	FMX-2203	100	-40 to +150	1.3	10	100	30	150(Ta)	30	500/500	25	500/1000	4.0	2.1
	20	TO-3PF (Center-tap)	FMX-4203S	100	-40 to +150	1.3	10	100	30	150	30	500/500	25	500/1000	2.0	6.5
	20	TO-220F (Center-tap)	FMXA-2203S	100	-40 to +150	1.3	10	100	30	150	25	500/500	-	-	4.0	2.1
	20	TO-3PF (Center-tap)	FMXA-4203S	100	-40 to +150	1.3	10	100	30	150	25	500/500	-	-	2.0	6.5

*Under development

• No. 13 Axial ($\phi 4.0/\phi 0.78$)

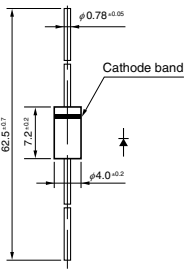

• No. 14 Axial ($\phi 4.0/\phi 0.98$)

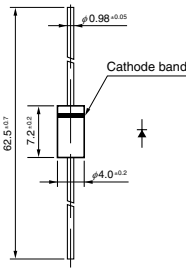

• No. 15 Axial ($\phi 6.5/\phi 1.4$)

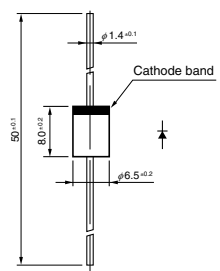

• No. 16 TO-220F (Two Elements)

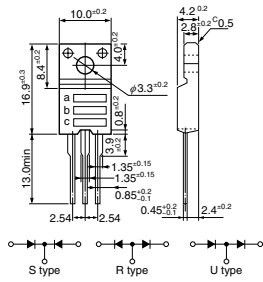

a: Part Number
b: Polarity
c: Lot No.

• No. 17 TO-220F (Center-tap)

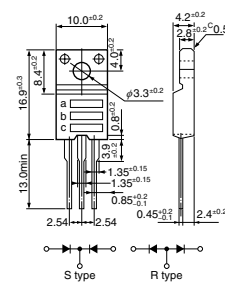

a: Part Number
b: Polarity
c: Lot No.

• No. 18 TO-220F2Pin

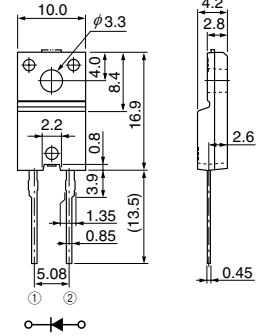

• No. 19 TO-220F2Pin (Two Elements)

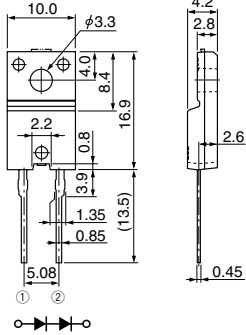

• No. 20 TO-3PF

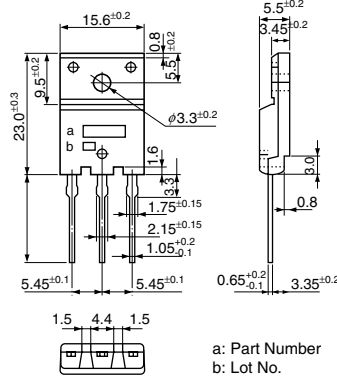

a: Part Number
b: Lot No.

• No. 21 TO-3PF2Pin

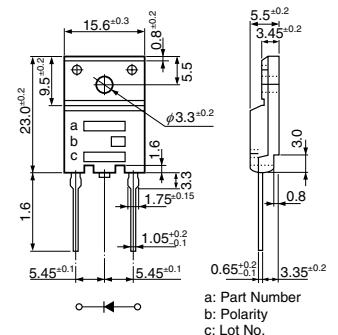

a: Part Number
b: Polarity
c: Lot No.