

4-4 Schottky Barrier Diodes

Standard

●Surface-Mount

V _{RM} (V)	I _F (AV) (A)	Package	Part Number	I _{FSM} (A)	T _j (°C)	T _{stg} (°C)	V _F (V) max	I _F (A)	I _R (mA)	I _{R(H)} (mA)	T _j (°C)	R _{th(j-l)} R _{th(j-c)} (°C/W)	Mass (g)
				50Hz Single Half Sine Wave					V _R =V _{RM} max	V _R =V _{RM} max			
40	1.0	Surface-Mount (SJP)	SJPB-D4	30	-40 to +150	0.55	1.0	0.1	35	150	20	0.072	
	2.0	Surface-Mount (SJP)	SJPB-H4	50	-40 to +150	0.55	2.0	0.2	70	150	20	0.072	
	3.0	Surface-Mount (SJP)	SJPB-L4	60	-40 to +150	0.55	3.0	0.3	100	150	20	0.072	
	3.0	Surface-Mount (D pack)	SPB-G34S	50	-40 to +150	0.55	3.0	3.5	100	150	5.0	0.29	
	5.0	Surface-Mount (D pack)	SPB-G54S	60	-40 to +150	0.55	5.0	5.0	175	150	5.0	0.29	
	6.0	Surface-Mount (D pack)Center-tap	SPB-64S	50	-40 to +150	0.55	3.0	3.5	100	150	5.0	0.29	
60	1.0	Surface-Mount (SJP)	SJPB-D6	20	-40 to +150	0.68	1.0	0.1	30	150	20	0.072	
	1.5	Surface-Mount (SJP)	SJPW-F6	25	-40 to +150	0.70	1.5	1.0	70	150	20	0.072	
	2.0	Surface-Mount (SJP)	SJPB-H6	40	-40 to +150	0.69	2.0	0.2	55	150	20	0.072	
	3.0	Surface-Mount (SJP)	SJPB-L6	50	-40 to +150	0.70	3.0	0.3	70	150	20	0.072	
	5.0	Surface-Mount (D pack)	SPB-G56S	60	-40 to +150	0.70	5.0	3.0	125	150	5.0	0.29	
90	1.0	Surface-Mount (SJP)	SJPB-D9	20	-40 to +150	0.85	1.0	0.1	30	150	20	0.072	
	2.0	Surface-Mount (SJP)	SJPB-H9	40	-40 to +150	0.85	2.0	0.2	55	150	20	0.072	
100	20	Surface-Mount (TO220S)Center-tap	MPE-220A	120	-40 to +150	0.85	10	1.0	100	150	2.5	1.04	

●Thru-Hole

V _{RM} (V)	I _F (AV) (A)	Package Axial (Body Diameter/Lead Diameter)	Part Number	I _{FSM} (A)	T _j (°C)	T _{stg} (°C)	V _F (V) max	I _F (A)	I _R (mA)	I _{R(H)} (mA)	T _j (°C)	R _{th(j-l)} R _{th(j-c)} (°C/W)	Mass (g)
				50Hz Single Half Sine Wave					V _R =V _{RM} max	V _R =V _{RM} max			
40	1.0	Axial(φ2.4/φ0.6)	AK 04	25	-40 to +150	0.55	1.0	5.0	35	150	22	0.13	
	1.0	Axial(φ2.7/φ0.6)	EK 04	40	-40 to +150	0.55	1.0	5.0	35	150	20	0.3	
	1.5	Axial(φ2.7/φ0.78)	EK 14	40	-40 to +150	0.55	1.5	5.0	50	150	17	0.3	
	1.7	Axial(φ4.0/φ0.78)	RK 14	60	-40 to +150	0.55	2.0	5.0	70	150	15	0.45	
	2.5	Axial(φ4.0/φ0.98)	RK 34	50	-40 to +150	0.55	2.5	5.0	100	150(Ta)	12	0.6	
	3.0	TO-220F2Pin	FMB-G14	60	-40 to +150	0.60	3.0	2.0	70	150	4.0	2.1	
	3.0	Axial(φ6.5/φ1.4)	RK 44	80	-40 to +150	0.55	3.0	5.0	100	150	8.0	1.2	
	4.0	TO-220F(Center-tap)	FMB-24	50	-40 to +150	0.55	2.0	5.0	250	150	4.0	2.1	
	5.0	Axial(φ6.5/φ1.4)	RW54	120	-40 to +150	0.55	5.0	1.0	150	150	8.0	1.2	
	5.0	TO-220F2Pin	FMB-G14L	60	-40 to +150	0.55	5.0	5.0	175	150(Ta)	4.0	2.1	
	6.0	TO-220F(Center-tap)	FMB-24M	60	-40 to +150	0.55	3.0	5.0	100	150(Ta)	4.0	2.1	
	10	TO-220F(Center-tap)	FMB-24L	60	-40 to +150	0.55	5.0	5.0	175	150	4.0	2.1	
	10	TO-220F(Center-tap)	FMW-24L	100	-40 to +150	0.55	5.0	0.5	175	150	4.0	2.1	
	10	TO-220F2Pin	FMB-G24H	150	-40 to +150	0.55	10	10	350	150	4.0	2.1	
	15	TO-220F(Center-tap)	FMB-24H	100	-40 to +150	0.55	7.5	7.5	250	150	4.0	2.1	
	15	TO-220F(Center-tap)	FMW-24H	120	-40 to +150	0.55	7.5	7.5	250	150(Ta)	4.0	2.1	
	20	TO-220F(Center-tap)	FMB-2204	150	-40 to +150	0.55	10	10	350	150	4.0	2.1	
	20	TO-220F(Center-tap)	FMW-2204	120	-40 to +150	0.55	10	1.0	350	150	4.0	2.1	
	30	TO-220F(Center-tap)	FMB-2304	150	-40 to +150	0.55	15	15	500	150	4.0	2.1	

• No. 13 Axial ($\phi 4.0/\phi 0.78$)

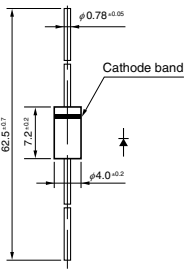

• No. 14 Axial ($\phi 4.0/\phi 0.98$)

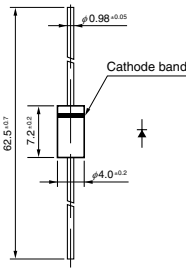

• No. 15 Axial ($\phi 6.5/\phi 1.4$)

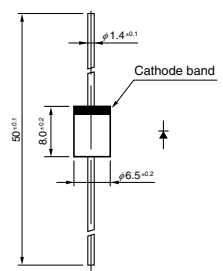

• No. 16 TO-220F (Two Elements)

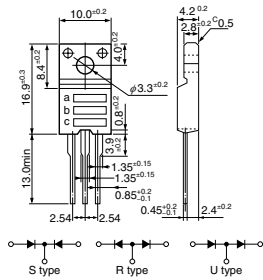

a: Part Number
b: Polarity
c: Lot No.

• No. 17 TO-220F (Center-tap)

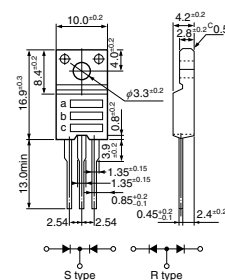

a: Part Number
b: Polarity
c: Lot No.

• No. 18 TO-220F2Pin

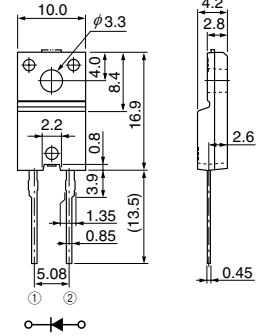

• No. 19 TO-220F2Pin (Two Elements)

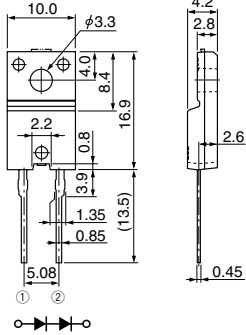

• No. 20 TO-3PF

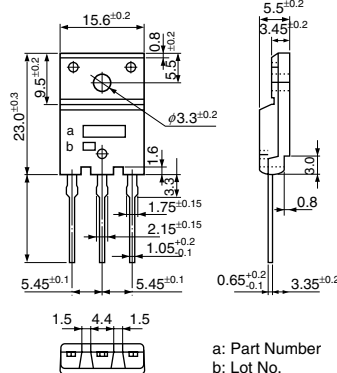

a: Part Number
b: Lot No.

• No. 21 TO-3PF2Pin

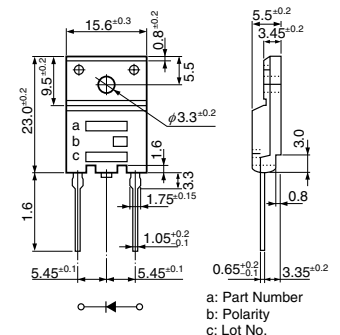

a: Part Number
b: Polarity
c: Lot No.