

4-3 Ultrafast Recovery Diodes

V _{RM} (V)	I _F (AV) (A) <small>Values in parentheses are for the products with heatsinks</small>	Package Axial <small>(Body Diameter/Lead Diameter)</small>	Part Number	I _{FSM} (A)	T _j (°C)	T _{stg} (°C)	V _F (V) max	I _F (A)	I _R (μA) V _R =V _{RM} max	I _R (H) (mA) V _R =V _{RM} max	T _j (°C)	trr ^① (ns)	I _F /I _{RP} (mA)	trr ^② (ns)	I _F /I _{RP} (mA)	R _{th(j-l)} (°C/W)	Mass (g)
				50Hz <small>Single Half Sine Wave</small>													
800	0.5	Axial (φ 2.4/ φ 0.6)	AB01B	10	-40 to +150	2.0	0.5	10	0.2	150	200	100/100	80	100/200	22	0.13	
	3.0	TO-220F (Two elements)	FMC-28U	50	-40 to +150	3.0	3.0	100	0.5	150	70	500/500	35	500/1000	4.0	2.1	
	3.0	TO-220F2Pin	FMC-G28S	50	-40 to +150	3.0	3.0	100	1.0	150	70	500/500	35	500/1000	4.0	2.1	
	5.0	TO-220F2Pin	FMC-G28SL	60	-40 to +150	3.0	5.0	200	2.0	150	70	500/500	35	500/1000	4.0	2.1	
1000	0.2	Axial (φ 2.4/ φ 0.6)	AP01C	5.0	-40 to +150	4.0	0.2	100	0.5	100	200	100/100	80	100/200	22	0.13	
	0.2	Axial (φ 2.7/ φ 0.6)	EP01C	5.0	-40 to +150	4.0	0.2	5.0	0.05	100(Ta)	200	100/100	80	100/200	20	0.2	
	0.4	Axial (φ 4.0/ φ 0.78)	RU 1P	10	-40 to +150	4.0	0.4	5.0	0.5	150	100	100/100	50	100/200	15	0.4	
	0.5	Axial (φ 2.7/ φ 0.6)	EG01C	10	-40 to +150	3.3	0.5	50	0.5	100(Ta)	100	100/100	50	100/200	20	0.2	
	0.7	Axial (φ 4.0/ φ 0.78)	RG 1C	10	-40 to +150	3.3	0.7	20	0.25	150	100	100/100	50	100/200	15	0.4	
	2.0	Axial (φ 6.5/ φ 1.4)	RG 4C	60	-40 to +150	3.0	2.0	500	2.5	100	100	500/500	50	500/1000	8.0	1.2	
	3.0	TO-220F2Pin	FMG-G2CS	30	-40 to +150	4.0	3.0	50	0.3	100	100	500/500	50	500/1000	4.0	2.1	
1200	3.0	TO-220F2Pin (Two elements)	FMC-26UA	50	-40 to +150	4.0	3.0	500	3.0	150	70	500/500	35	500/1000	4.0	2.1	
→ 1600	3.0	TO-220F2Pin (Two elements)	FMC-28UA	50	-40 to +150	6.0	3.0	100	0.5	150	70	500/500	35	500/1000	4.0	2.1	
2000	0.1	Axial (φ 4.0/ φ 0.78)	RP 1H	5.0	-40 to +150	7.0	0.1	2.0	0.01	100	100	10/20	50	10/20	15	0.4	

• No. 13 Axial ($\phi 4.0/\phi 0.78$)

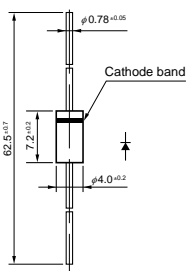

• No. 14 Axial ($\phi 4.0/\phi 0.98$)

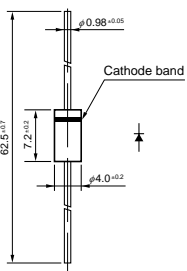

• No. 15 Axial ($\phi 6.5/\phi 1.4$)

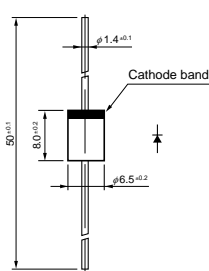

• No. 16 TO-220F (Two Elements)

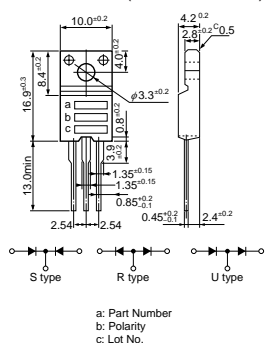

• No. 17 TO-220F (Center-tap)

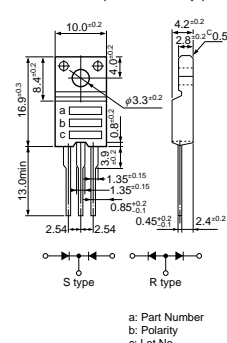

• No. 18 TO-220F2Pin

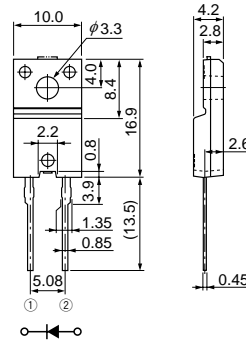

• No. 19 TO-220F2Pin (Two Elements)

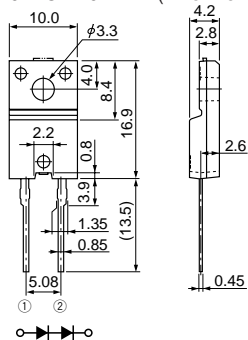

• No. 20 TO-3PF

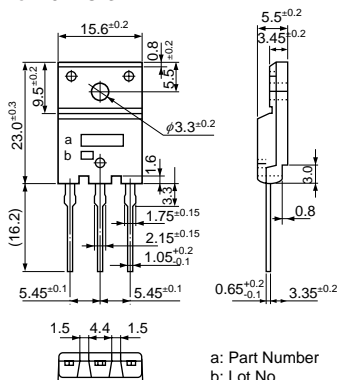

• No. 21 TO-3PF2Pin

