

# 4-1 Rectifier Diodes

## ●Surface-Mount

V <sub>RM</sub> (V)	I <sub>F</sub> (AV) (A) <small>Values in parentheses are for the products with heatsinks</small>	Package	Part Number	I <sub>FSM</sub> (A)	T <sub>J</sub> (°C)	T <sub>stg</sub> (°C)	V <sub>F</sub> (V) max	I <sub>F</sub> (A)	I <sub>R</sub> (μA)	I <sub>R(H)</sub> (μA)	T <sub>J</sub> (°C)	R <sub>th(j-l)</sub> R <sub>th(j-c)</sub> (°C/W)	Mass (g)
				50Hz <small>Single Half Sine Wave</small>					V <sub>R</sub> =V <sub>RM</sub> max	V <sub>R</sub> =V <sub>RM</sub> max			
400	2.0	Surface-Mount (SJP)	SJPM-H4	45	-40 to +150		1.1	2.0	10	50	150	20	0.072

## ●Thru-Hole

V <sub>RM</sub> (V)	I <sub>F</sub> (AV) (A) <small>Values in parentheses are for the products with heatsinks</small>	Package Axial <small>(Body Diameter/Lead Diameter)</small>	Part Number	I <sub>FSM</sub> (A)	T <sub>J</sub> (°C)	T <sub>stg</sub> (°C)	V <sub>F</sub> (V) max	I <sub>F</sub> (A)	I <sub>R</sub> (μA)	I <sub>R(H)</sub> (μA)	T <sub>J</sub> (°C)	R <sub>th(j-l)</sub> R <sub>th(j-c)</sub> (°C/W)	Mass (g)
				50Hz <small>Single Half Sine Wave</small>					V <sub>R</sub> =V <sub>RM</sub> max	V <sub>R</sub> =V <sub>RM</sub> max			
100	1.0	Axial(φ2.7/φ0.78)	EM 1Y	45	-40 to +150		0.97	1.0	10	500	150	17	0.3
	3.0	Axial(φ6.5/φ1.4)	RM 4Y	200	-40 to +150		0.95	3.0	10	50	150	8.0	1.2
200	1.0	Axial(φ2.4/φ0.6)	AM01Z	35	-40 to +150		0.98	1.0	10	50	100(Ta)	22	0.13
	1.0	Axial(φ2.7/φ0.6)	EM01Z	45	-40 to +150		0.97	1.0	10	50	100	20	0.2
	1.0	Axial(φ2.7/φ0.78)	EM 1Z	45	-40 to +150		0.97	1.0	10	500	150	17	0.3
	1.0	Axial(φ4.0/φ0.78)	RM 1Z	50	-40 to +150		0.95	1.0	5	50	100	15	0.4
	1.2	Axial(φ4.0/φ0.98)	RO 2Z	80	-40 to +150		0.92	1.5	10	50	100(Ta)	12	0.61
	1.2	Axial(φ4.0/φ0.98)	RM 2Z	100	-40 to +150		0.91	1.5	10	50	100	12	0.6
	1.5	Axial(φ4.0/φ0.78)	RM 10Z	120	-40 to +150		0.91	1.5	10	50	100(Ta)	15	0.4
	3.0	Axial(φ6.5/φ1.4)	RM 4Z	200	-40 to +150		0.95	3.0	10	50	100(Ta)	8.0	1.2
	10	TO-220F(Center-tap)	FMM-22S, R	100	-40 to +150		1.1	5.0	10	100	150	4.0	2.1
	400	1.0	Axial(φ2.4/φ0.6)	AM01	35	-40 to +150		0.98	1.0	10	50	100(Ta)	22
1.0		Axial(φ2.7/φ0.6)	EM01	45	-40 to +150		0.97	1.0	10	50	100(Ta)	20	0.2
1.0		Axial(φ2.7/φ0.78)	EM 1	45	-40 to +150		0.97	1.0	10	500	150	17	0.3
1.0		Axial(φ4.0/φ0.78)	RM 1	50	-40 to +150		0.95	1.0	5.0	50	100(Ta)	15	0.4
1.2		Axial(φ2.7/φ0.78)	EM 2	80	-40 to +150		0.92	1.2	10	500	150	17	0.3
1.2		Axial(φ4.0/φ0.98)	RO 2	80	-40 to +150		0.92	1.5	10	50	100(Ta)	12	0.61
1.2		Axial(φ4.0/φ0.98)	RM 2	100	-40 to +150		0.91	1.5	10	50	100	12	0.6
1.2		Axial(φ4.0/φ0.78)	RM 10	150	-40 to +150		0.91	1.5	10	50	100	15	0.4
3.0		Axial(φ6.5/φ1.4)	RM 4	200	-40 to +150		0.95	3.0	10	50	150	8.0	1.2
10		TO-220F(Center-tap)	FMM-24S, R	100	-40 to +150		1.1	5.0	10	100	150	4.0	2.1
600	1.0	Axial(φ2.4/φ0.6)	AM01A	35	-40 to +150		0.98	1.0	10	50	100(Ta)	22	0.13
	1.0	Axial(φ2.7/φ0.6)	EM01A	45	-40 to +150		0.97	1.0	10	50	100(Ta)	20	0.2
	1.0	Axial(φ2.7/φ0.78)	EM 1A	45	-40 to +150		0.97	1.0	10	500	150	17	0.3
	1.0	Axial(φ4.0/φ0.78)	RM 1A	50	-40 to +150		0.95	1.0	5.0	50	100	15	0.4
	1.2	Axial(φ2.7/φ0.78)	EM 2A	80	-40 to +150		0.92	1.2	10	50	100	17	0.3
	1.2	Axial(φ4.0/φ0.78)	RM 11A	100	-40 to +150		0.92	1.5	10	50	100	15	0.4
	1.2	Axial(φ4.0/φ0.98)	RM 2A	100	-40 to +150		0.91	1.5	10	50	100	12	0.6
	1.2	Axial(φ4.0/φ0.78)	RM 10A	150	-40 to +150		0.91	1.5	10	50	100	15	0.4
	3.0	Axial(φ6.5/φ1.4)	RM 4A	200	-40 to +150		0.95	3.0	10	50	150	8.0	1.2
	3.2	Axial(φ6.5/φ1.4)	RM 4AM	350	-40 to +150		0.92	3.5	10	50	100	8.0	1.2
10	TO-220F(Center-tap)	FMM-26S, R	100	-40 to +150		1.1	5.0	10	100	150	4.0	2.1	
800	0.8	Axial(φ4.0/φ0.78)	RM 1B	40	-40 to +150		1.2	1.0	5	50	100(Ta)	15	0.4
	1.0	Axial(φ2.7/φ0.78)	EM 1B	35	-40 to +150		1.05	1.0	20	200	150	17	0.3
	1.2	Axial(φ2.7/φ0.78)	EM 2B	80	-40 to +150		0.92	1.2	10	500	150	17	0.3
	1.2	Axial(φ4.0/φ0.98)	RO 2B	80	-40 to +150		0.92	1.5	10	50	100(Ta)	12	0.61
	1.2	Axial(φ4.0/φ0.78)	RM 11B	100	-40 to +150		0.92	1.5	10	50	100(Ta)	15	0.4
	1.2	Axial(φ4.0/φ0.98)	RM 2B	100	-40 to +150		0.91	1.5	10	50	100	12	0.6
	1.2	Axial(φ4.0/φ0.78)	RM 10B	150	-40 to +150		0.91	1.5	10	50	100(Ta)	15	0.4
1000	0.8	Axial(φ4.0/φ0.78)	RM 1C	40	-40 to +150		1.2	1.0	5.0	100	100(Ta)	15	0.4
	1.0	Axial(φ2.7/φ0.78)	EM 1C	35	-40 to +150		1.05	1.0	20	200	150	17	0.3
	1.2	Axial(φ4.0/φ0.98)	RO 2C	80	-40 to +150		0.92	1.5	10	50	100(Ta)	12	0.61
	1.2	Axial(φ4.0/φ0.78)	RM 11C	100	-40 to +150		0.92	1.5	10	50	100	15	0.4
	1.2	Axial(φ4.0/φ0.98)	RM 2C	100	-40 to +150		0.91	1.5	10	50	100	12	0.6
	3.0	Axial(φ6.5/φ1.4)	RM 4C	150	-40 to +150		0.97	3.0	10	50	100	8.0	1.2

# Package Type (Dimensions)

• No. 1 Surface-Mount (SJP)



• No. 2 Surface-Mount (D pack)

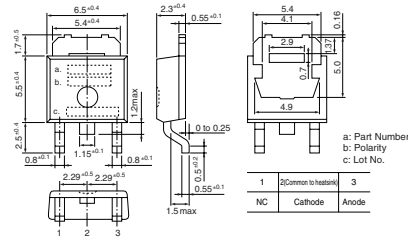

• No. 3 Surface-Mount (D pack) Center-tap

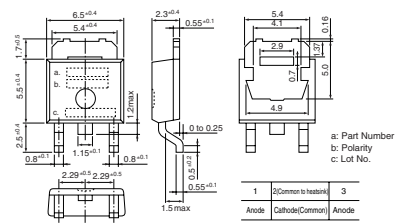

• No. 4 Surface-Mount (TO263)



• No. 5 Surface-Mount (TO220S)  
MPL-102S, MP2-202S, MPL-1036

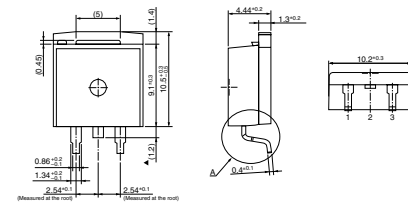

• No. 6 Surface-Mount (TO220S)

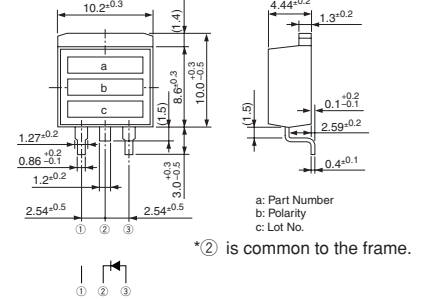

• No. 7 Surface-Mount (TO220S) Center-tap

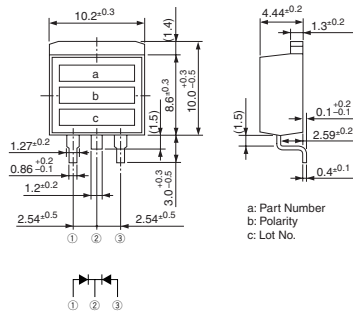

• No. 8 Surface-Mount (SZ-10)

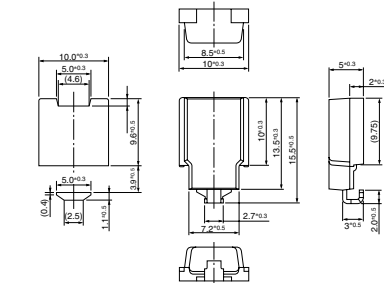

• No. 9 Axial (φ2.4/φ0.6)

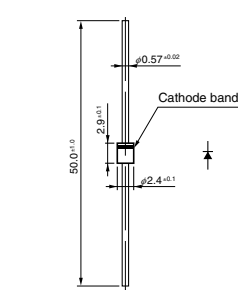

• No. 10 Axial (φ2.7/φ0.6)

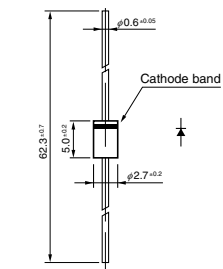

• No. 11 Axial (φ2.7/φ0.6)  
Silicon Varistors (Symmetrical)

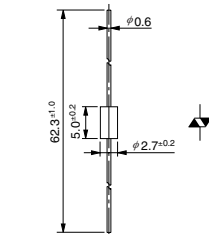

• No. 12 Axial (φ2.7/φ0.78)

